

CG12-42X 12V 42Ah(10hr)

Gel battery shows some distinctive advantages over flooded battery or AGM battery, such as super thermal stability, high deep discharge capability, good recovery from deep discharge, even if the battery is left discharged for three days, it will recover to 100% of capacity. With the above-mentioned advantages, the gel battery has long service life, specially suitable for motive power applications, such as golf trailer, srubber, folklift, etc. The deep discharge cycles increased 50% as compared with the AGM battery.

Battery Construction

Component	Positive plate	Negative plate	Container	Cover	Safety valve	Terminal	Separator	Electrolyte
Raw material	Lead dioxide	Lead	ABS	ABS	Rubber	Copper	PVC	Gelled acid

General Features

- Nanometer SiO₂ and H₂SO₄ gelled electrolyte technology for efficiency gas recombination of up to 99% and freedom from electrolyte maintenance or water adding.
- Not restricted for air transport-complies with IATA/ICAO Special Provision A67.
- UL-recognized component.
- Can be mounted in any orientation.
- Computer designed lead, calcium tin alloy grid for high power density.
- Long service life, float or cyclic applications.
- Maintenance-free operation.
- Low self discharge.
- Case and cover available in both standard and flame retardant ABS.

Dimensions and Weight

Length(mm / inch)	229 / 9.02
Width(mm / inch)	138 / 5.43
Height(mm / inch)	208 / 8.19
Total Height(mm / inch)	213 / 8.39
Approx. Weight(Kg / lbs)	16.8 / 37.1

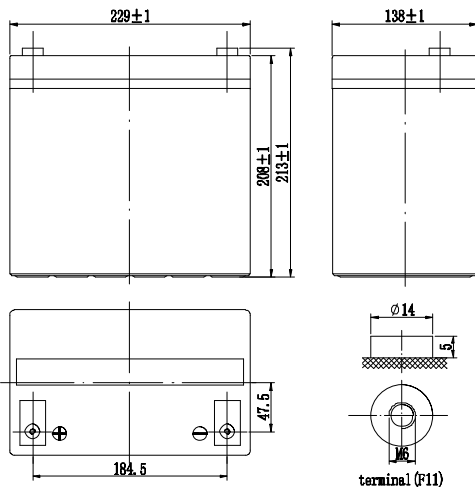

Performance Characteristics

Nominal Voltage	12V
Number of cell	6
Design Life	12 years
Nominal Capacity 77°F(25°C)	
10 hour rate (4.2A, 10.8V)	42.0Ah
5 hour rate (7.39A, 10.5V)	36.95Ah
1 hour rate (26.0A, 9.6V)	26.0Ah
Internal Resistance	
Fully Charged battery 77°F(25°C)	9.0mOhms
Self-Discharge	
2% of capacity declined per month at 20°C(average)	
Operating Temperature Range	
Discharge	-20~60°C
Charge	-10~60°C
Storage	-20~60°C
Max. Discharge Current 77°F(25°C)	500A(5s)
Short Circuit Current	1300A
Charge Methods: Constant Voltage Charge 77°F(25°C)	
Cycle use	14.28-14.52V
Maximum charging current	16.5A
Temperature compensation	-20mV/°C
Standby use	13.38-13.68V
No charge current limit is required	
Temperature compensation	-30mV/°C

Discharge Constant Current (Amperes at 77°F25°C)

End point volts/cell	10min	15min	30min	1h	3h	5h	10h	20h
1.60V	88.2	72.2	42.0	26.0	10.9	7.98	4.41	2.35
1.65V	83.2	67.2	41.2	25.2	10.6	7.73	4.37	2.31
1.70V	78.1	63.8	40.3	24.4	10.4	7.56	4.28	2.27
1.75V	73.1	58.8	39.5	23.5	10.2	7.39	4.24	2.25
1.80V	68.0	53.8	37.8	22.3	9.80	7.14	4.20	2.21

Discharge Constant Power (Watts at 77°F25°C)

End point volts/cell	10min	15min	30min	1h	3h	5h	10h	20h
1.60V	151	123	78.6	48.7	20.4	15.3	8.54	4.63
1.65V	144	121	75.1	46.4	19.4	14.5	7.90	4.36
1.70V	140	116	71.6	44.4	18.4	13.8	7.61	4.17
1.75V	133	109	69.5	42.9	17.5	13.5	7.33	4.03
1.80V	126	103	66.5	41.0	16.5	12.6	6.85	3.88

(Note)The above characteristics data are average values obtained within three charge/discharge cycles not the minimum values.

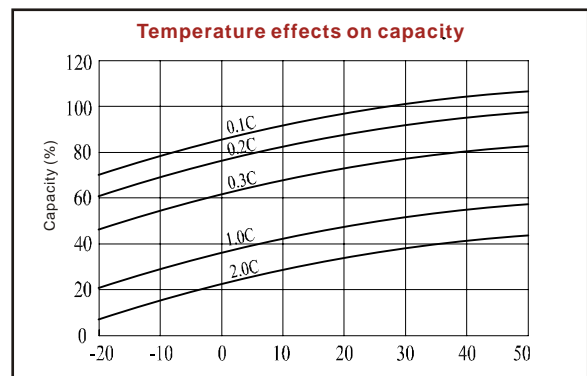
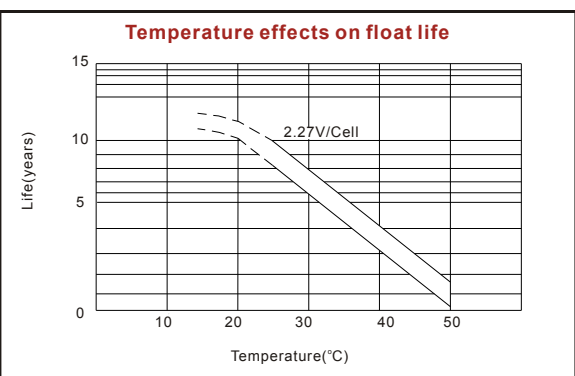
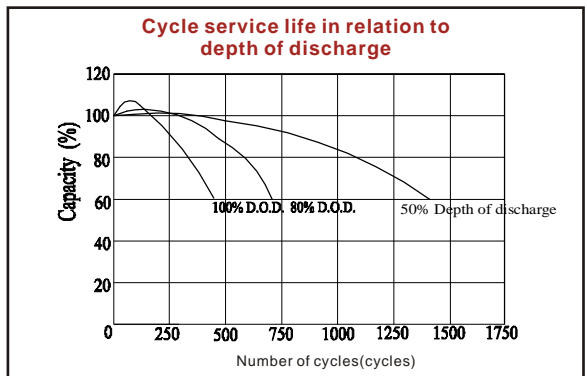
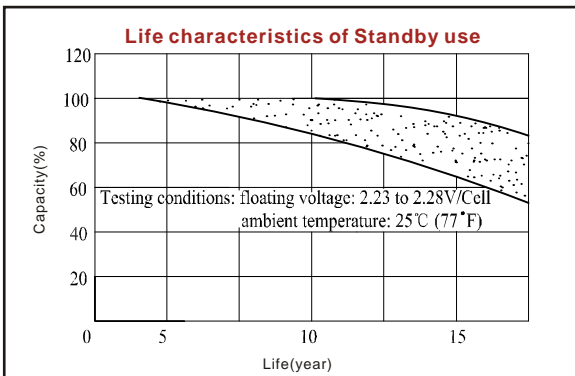
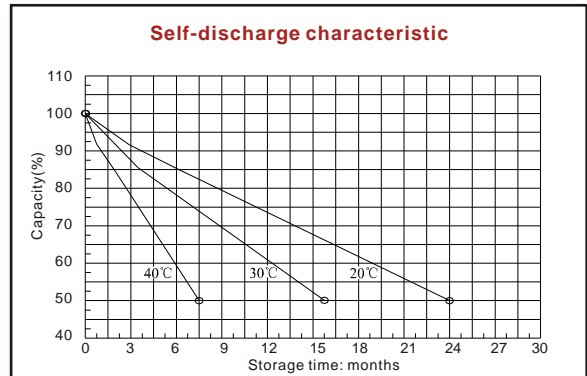
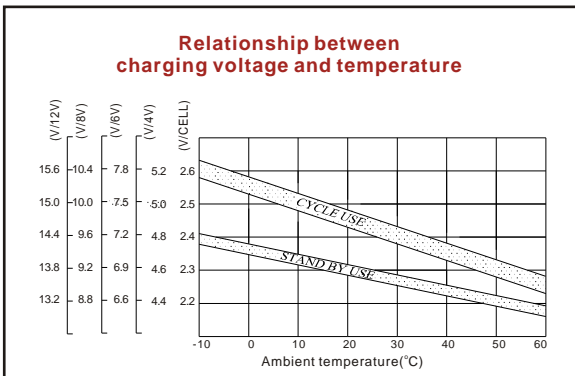
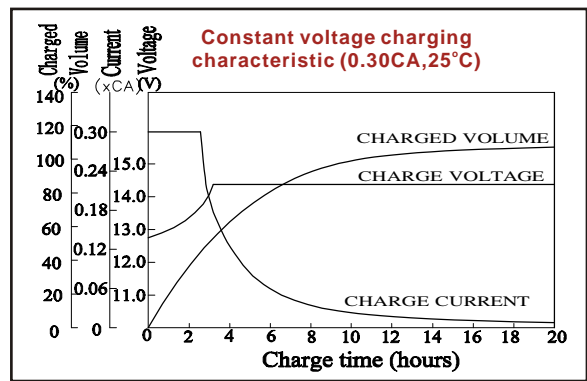
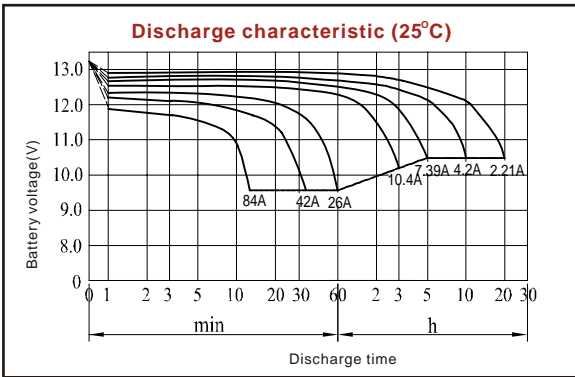

ISO9001:2000

MH25860

G4M19906-9202-E-16

www.vision-batt.com

Shenzhen Center Power Tech. Co., Ltd.
 Center Power Industrial Park, Tongfu Industrial District Dapeng Town, 518120 Shenzhen, China
 Tel: (+86-755) 8431 8088 Fax: (+86-755) 8431 8038 E-mail: sales@vision-batt.com